

OPITEC

107.953

Solar driven wind generator



Please Note

The OPITEC range of projects is not intended as play toys for young children. They are teaching aids for young people learning the skills of Craft, Design and Technology. These projects should only be undertaken and tested with the guidance of a fully qualified adult.

The finished projects are not suitable to give to children under 3 years old. Some parts can be swallowed. Danger of suffocation!

Necessary Tools

Pencil , ruler
All purpose glue, wood glue
Sellotape
Side cutters, combination pliers
Pillar drill
Machine vice
Vice jaws
Drill 5mm diameter
Forstner bit 20mm,25mm
Sand paper
Fine saw
File
Chisel 5/6mm

<i>Parts list</i>	Quantity	Size mm	Description	Part No.
Plywood	1	15x100x200	Base	1
Hard paper tube	1	Ø19,5 x300	Mast	2
Wood strip	1	30x30x150	Housing	3/4
Solar motor	1	Ø24	RF 300	5
Solar cell	1	1V, 250mA		6
Propellor	1	Ø 210	Rotor	7
Wire	2	500		8

Instructions

1. Mark out the base on the plywood sheet (1) as shown
Drill the 20 mm and 5mm diameter holes.
Adhere to the safety rules when drilling !!

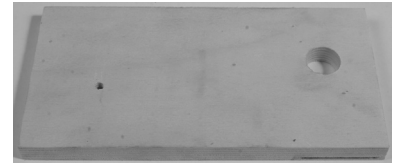
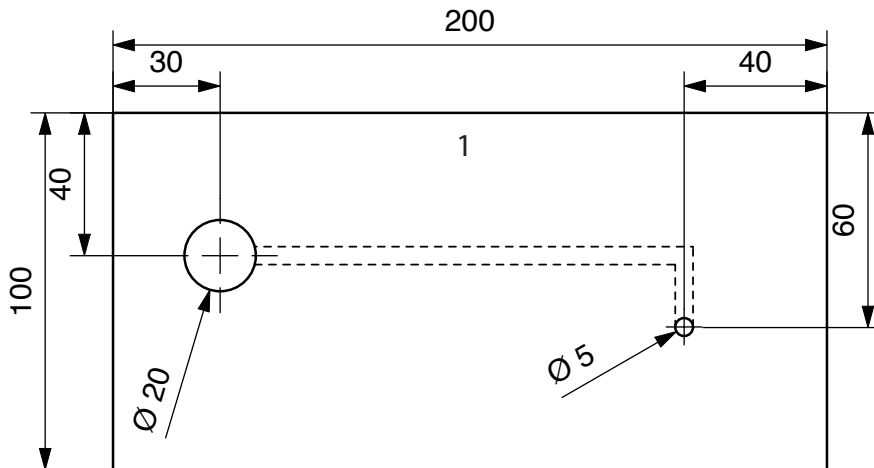

2. Turn the base over, mark out a groove between the 5mm and the 20mm hole and carefully chisel it out to a depth of 3mm.

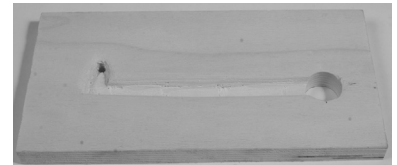

3. Shorten the hard paper tube to 270mm long with a fine saw.



4. Mark out the solar house (4) for the sides on the wood (3). Saw the sloping side and drill the 5mm hole in the middle. Mark out and file the 2mm deep groove underneath for the wiring, from the high side to the 5 mm hole

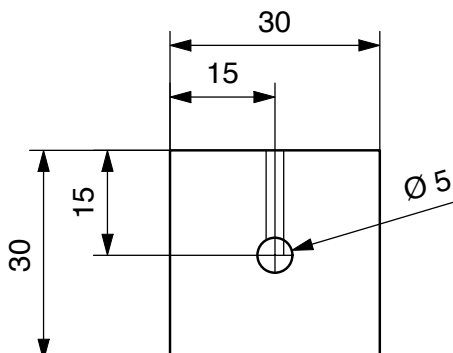
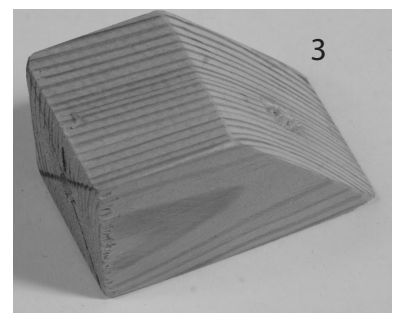
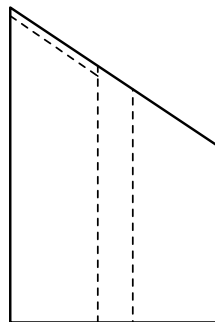
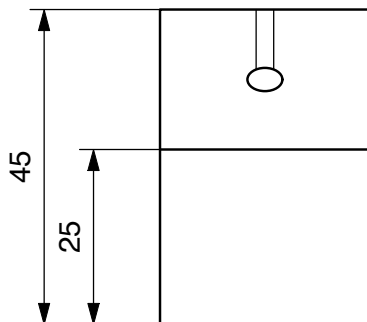

cable channel

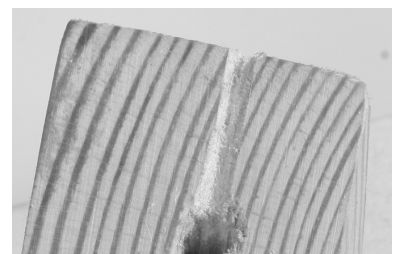

BAUANLEITUNG

5. Mark out the size of the gondola housing (4) on the remainder of the wood. (3) Saw it off mark out and drill the holes 20 and 25mm with a forstner bit
Saw the sloping part of the housing, file and sand to shape

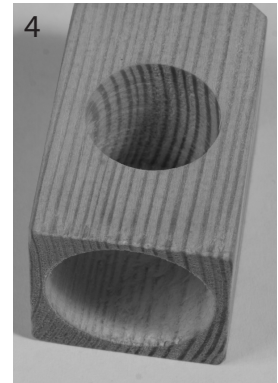
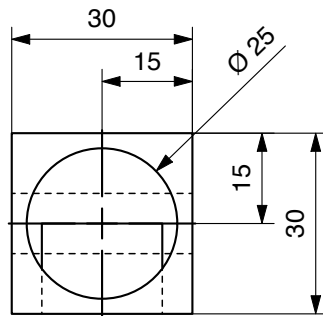
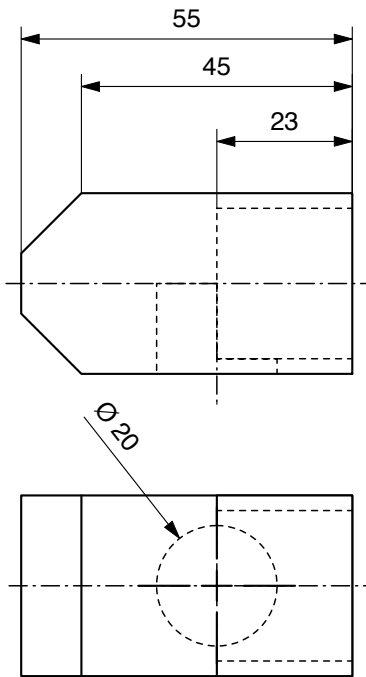

6. Separate the cables. Thread them from underneath base making sure that they lay in the channel. Then guide the cable up through the mast and into the 5mm diameter hole the gondola housing

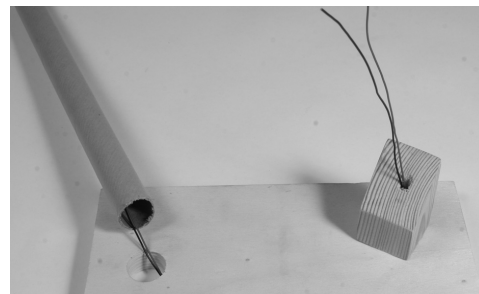
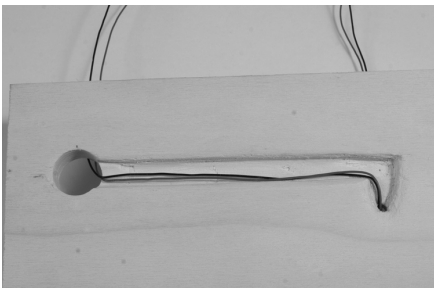

7. Glue the mast in the 20mm hole in the base, use a try square to make sure that it is upright.

8. Glue the lower solar cell house to the base making sure that the 5mm diameter holes line up and that the cable is not caught up anywhere.

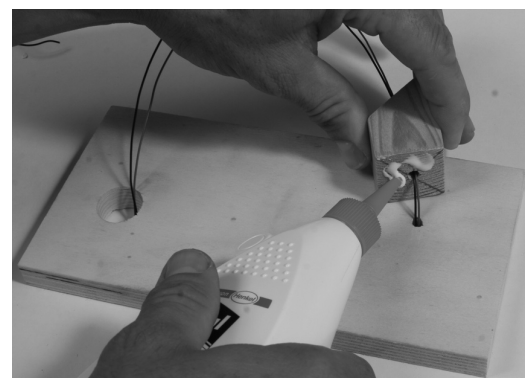
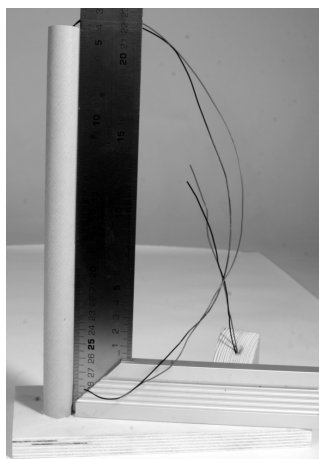

Instructions

9. Guide the cable up through the 25mm hole in the gondola housing Glue the gondola housing to the mast making sure that everything is upright.

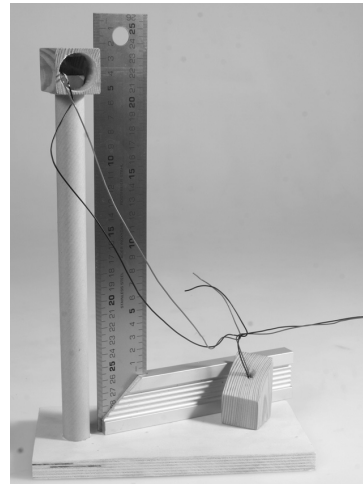
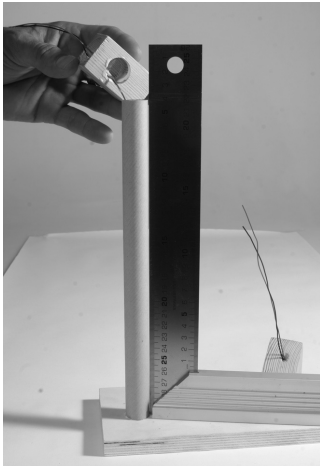

10. Shorten the wires coming from the housing to 50mm and then remove 10mm insulation from the end of each wire.

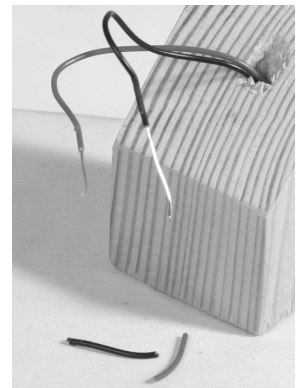
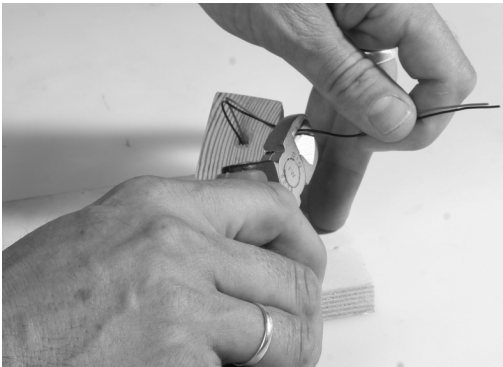

11. Twist the black wire from the motor with the black wire from the housing. Then join the red wires together in the same way.

Note: Solder the twisted joints together

Insulate the joints with sellotape or insulation tape

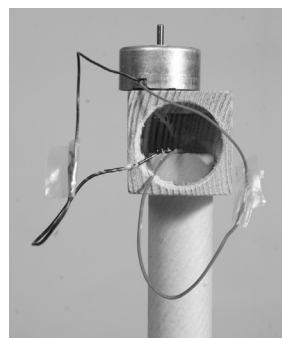
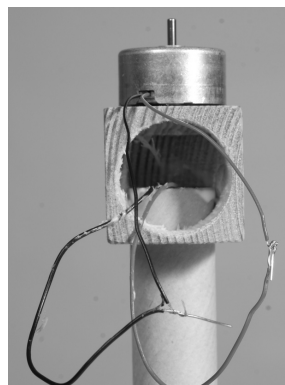

12. Solder the tabs on the end of the wires that join on to the solar cell
Join the black cable with the minus connection on the solar cell
Join the red cable to the plus pole on the cell

Note the wire can also be soldered directly to the cell

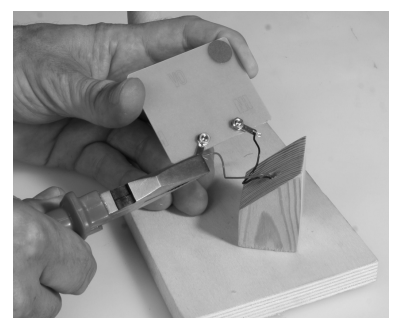

Instructions

13. Assemble the rotor by removing the parts and cleaning off any remaining plastic sprue
Join the blades to the hub

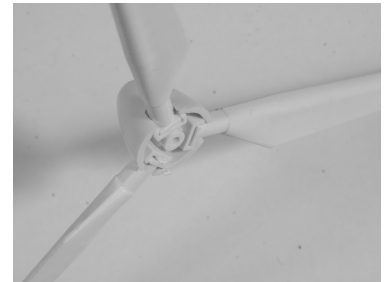
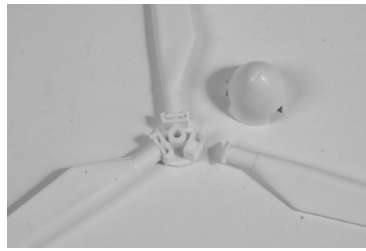
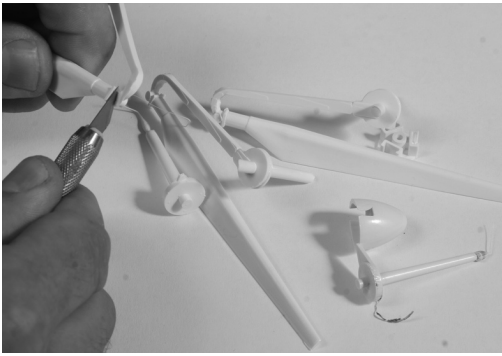

14. Testing
Press the propeller on the shaft of the motor
Place near a 60 Watt bulb and the rotor should turn
If the rotor does not turn check the wiring



15. When you are satisfied remove the propeller and then you can glue the motor into the gondola housing.
Push any excess wire back into the housing and glue the motor in place.
Making sure that no glue gets on to the motor shaft.

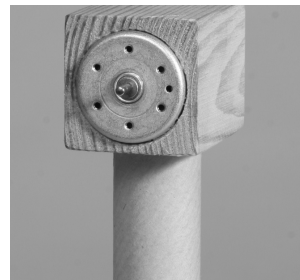
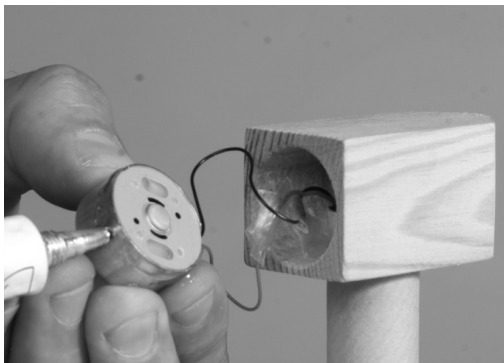

16. Glue the solar cell centrally on its house on the base making sure all the wires are in their correct grooves. Glue the wires if necessary.

Replace the rotor on the motor shaft

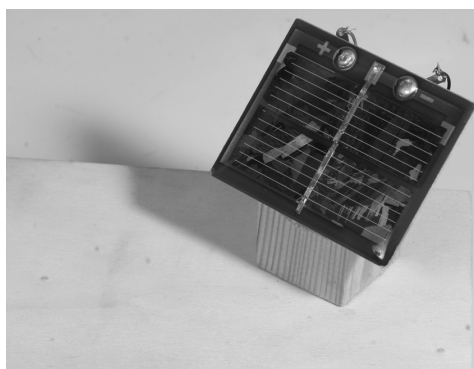

Instructions

17. The final finish is left up to you. Shown below is a suggestion for the final look

